

# Installation Manual

## NNR25 Vertical ceiling mounted accessories V1.1

Single Ended

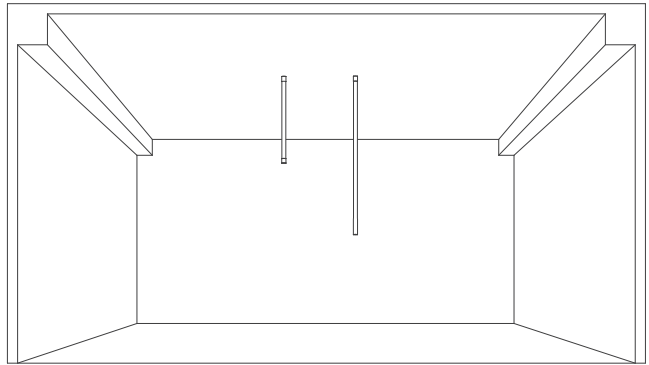

Double Ended

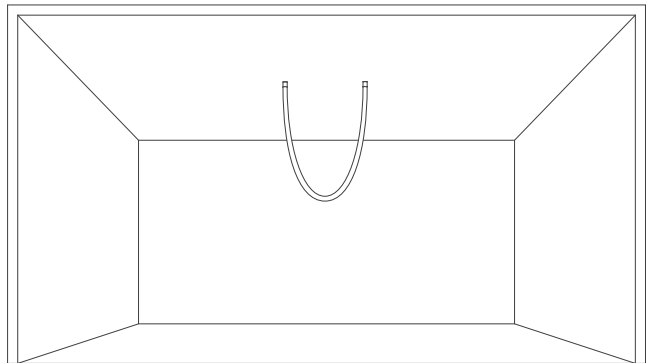

Please read this manual carefully before installation, and install the product in the correct way.  
Please keep it after reading, so that all users of this product can check it at any time.

## Prepare materials- Single Ended



Neon strip



Manual



Rubber plug screw



End capscrew



Countersunk screw



PC tube



Metal accessories



Allen wrench

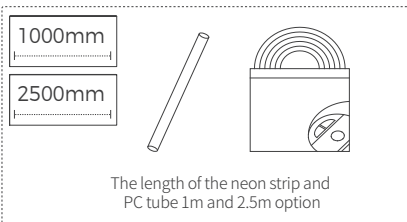
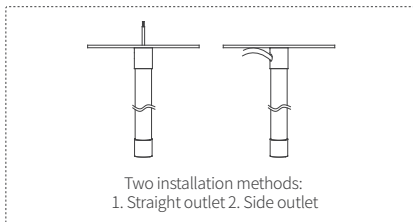

## Prepare materials- Double Ended



Neon strip



Manual



Rubber plug screw



Countersunk screw



Metal accessories



Allen wrench

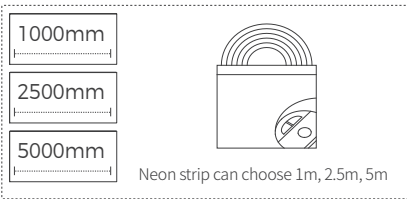
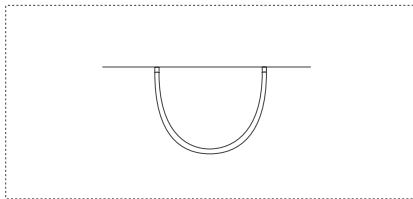

## Installation tools



Phillips screwdriver



Slotted screwdriver



Pen

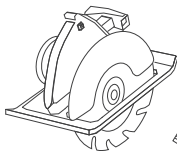

Cutting Machine



Tape measure

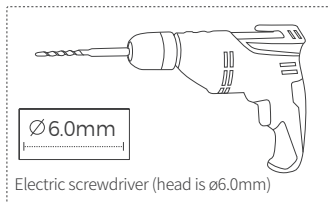

# Installation Steps

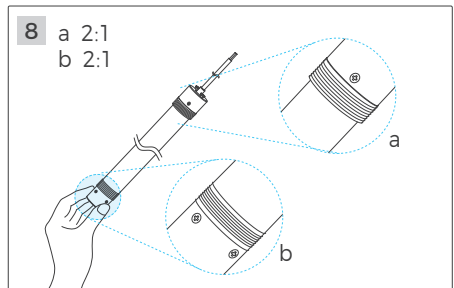
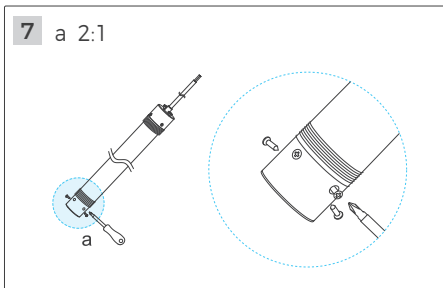
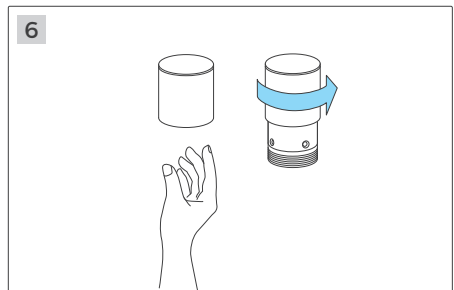
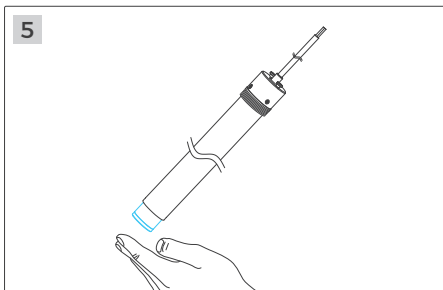
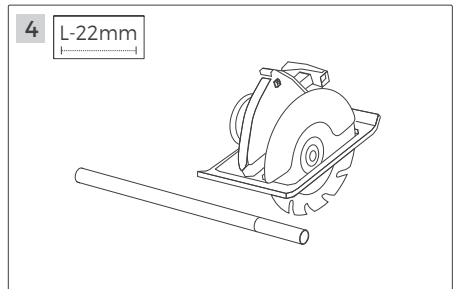
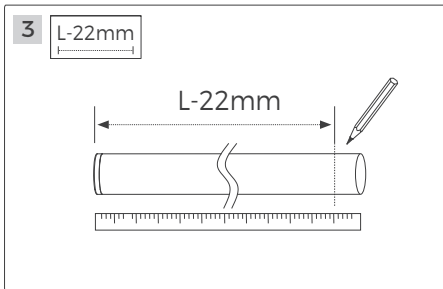
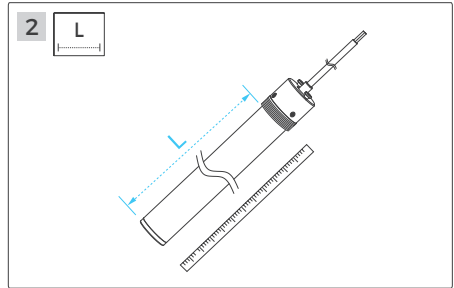
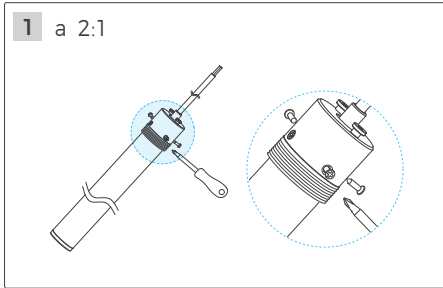

# 📖 Installation Steps - Single Ended

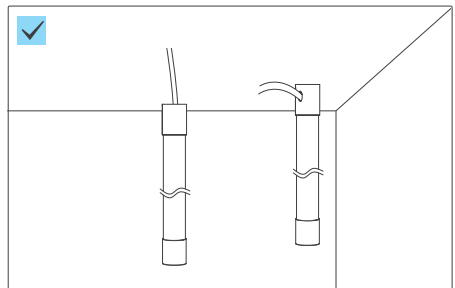
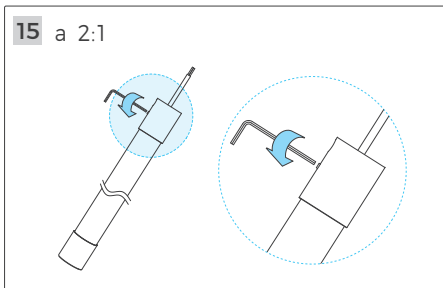
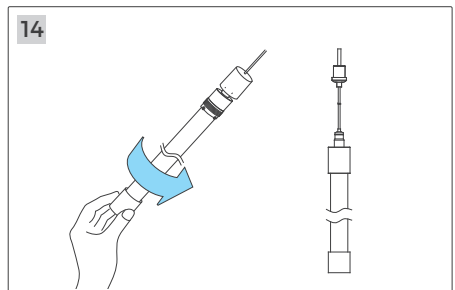
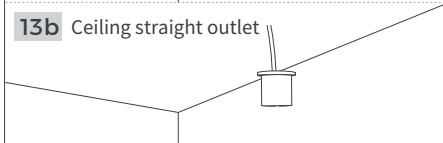
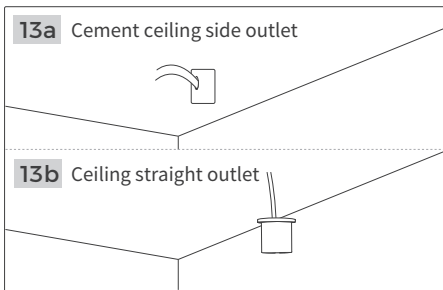
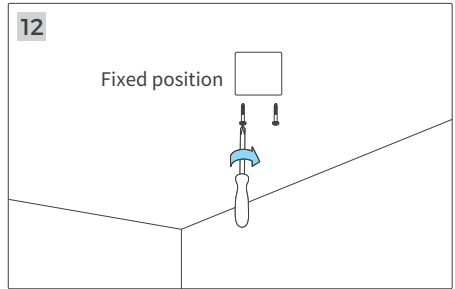
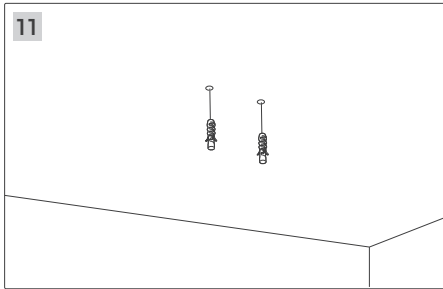
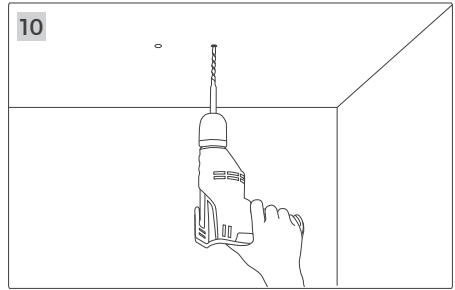
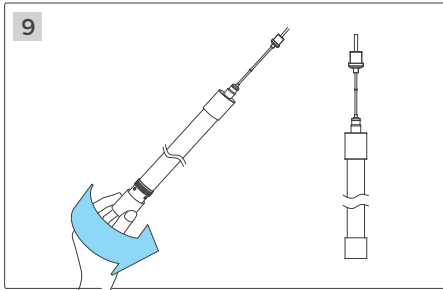

# Installation Steps - Double Ended

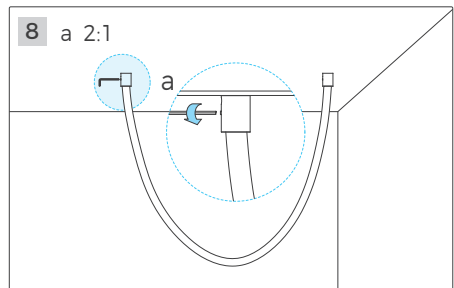
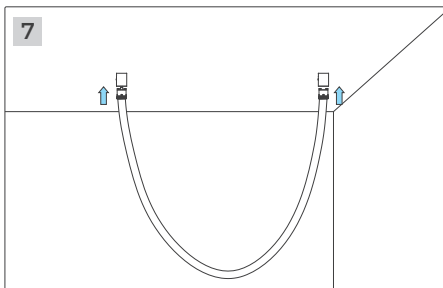
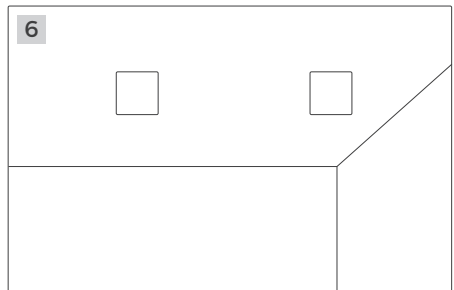
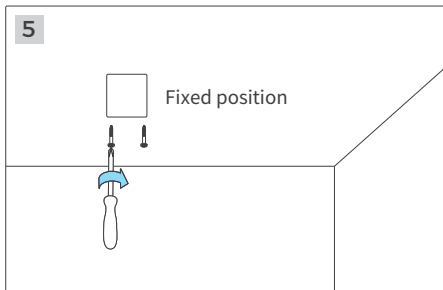
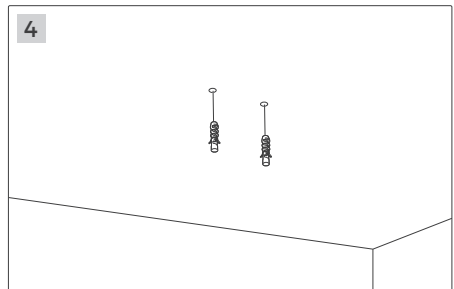
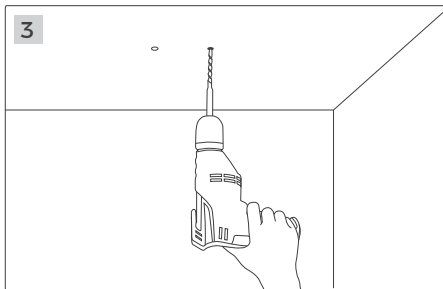
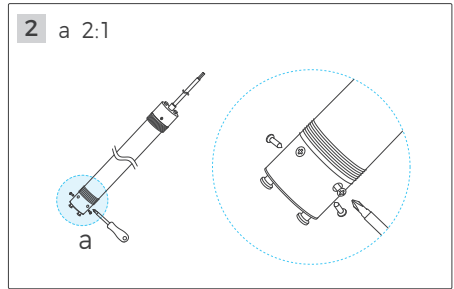
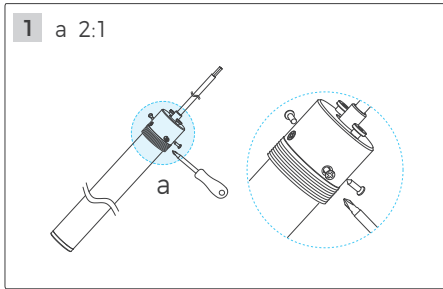



# Parameters

Code	Wire length	Load bearing	Outlet	Adaptation model
AS-NNR25VCC-1000	2M	4kg	Side/ Top	NNR25-XXCSN050CC0100
AS-NNR25VCC-2500	2M	4kg	Side/ Top	NNR25-XXCSN050CC0250
				NNR25-XXCSN050CC0100
AS-NNR25VCC-XX-2	/	4kg	Side/ Top	NNR25-XXCSN050CC0250
				NNR25-XXCSN050CC0500



**Tel:** +86-755-2923-1888  
**E-mail:** colors@colorsled.com  
**Web:** www.colorsled.com  
**Add:** Building A5, Qixing Wisdom Park, Shiyan Youth Road,  
Bao'an District, Shenzhen, China

